

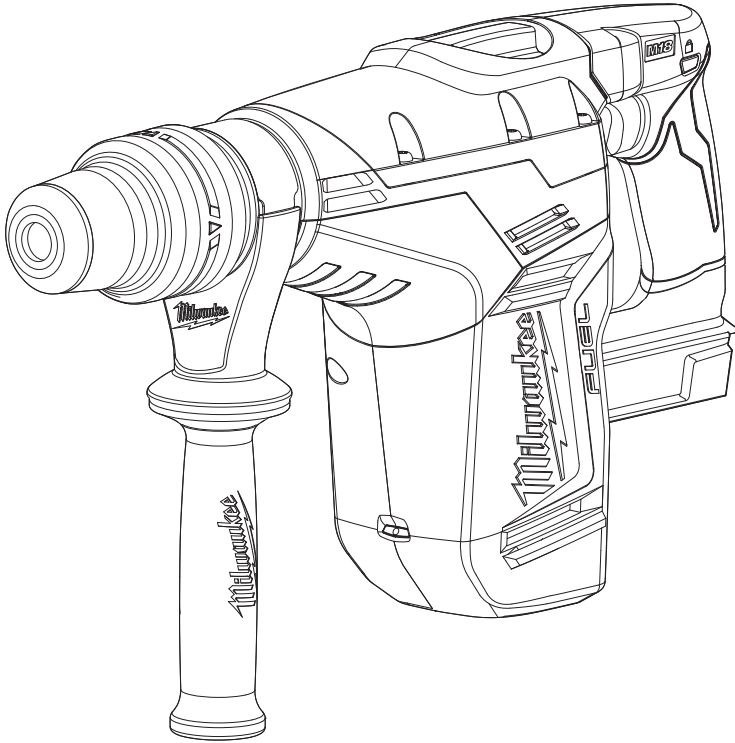

OPERATOR'S MANUAL



Cat. No.

M18 CHM



M18 FUEL™ 40 MM (1-9/16") SDS MAX ROTARY HAMMER

WARNING

To reduce the risk of injury, user must read and understand operator's manual.



GENERAL POWER TOOL SAFETY WARNINGS

⚠WARNING Read all safety warnings, instructions, illustrations and specifications provided with this power tool. Failure to follow all instructions listed below may result in electric shock, fire and/or serious injury. **Save all warnings and instructions for future reference.** The term "power tool" in the warnings refers to your mains-operated (corded) power tool or battery-operated (cordless) power tool.

WORK AREA SAFETY

- **Keep work area clean and well lit.** Cluttered or dark areas invite accidents.
- **Do not operate power tools in explosive atmospheres, such as in the presence of flammable liquids, gases or dust.** Power tools create sparks which may ignite the dust or fumes.
- **Keep children and bystanders away while operating a power tool.** Distractions can cause you to lose control.

ELECTRICAL SAFETY

- **Power tool plugs must match the outlet. Never modify the plug in any way. Do not use any adapter plugs with earthed (grounded) power tools.** Unmodified plugs and matching outlets will reduce risk of electric shock.
- **Avoid body contact with earthed or grounded surfaces, such as pipes, radiators, ranges and refrigerators.** There is an increased risk of electric shock if your body is earthed or grounded.
- **Do not expose power tools to rain or wet conditions.** Water entering a power tool will increase the risk of electric shock.
- **Do not abuse the cord. Never use the cord for carrying, pulling or unplugging the power tool. Keep cord away from heat, oil, sharp edges or moving parts.** Damaged or entangled cords increase the risk of electric shock.
- **When operating a power tool outdoors, use an extension cord suitable for outdoor use.** Use of a cord suitable for outdoor use reduces the risk of electric shock.
- **If operating a power tool in a damp location is unavoidable, use a ground fault circuit interrupter (GFCI) protected supply.** Use of an GFCI reduces the risk of electric shock.

PERSONAL SAFETY

- **Stay alert, watch what you are doing and use common sense when operating a power tool. Do not use a power tool while you are tired or under the influence of drugs, alcohol or medication.** A moment of inattention while operating power tools may result in serious personal injury.
- **Use personal protective equipment. Always wear eye protection.** Protective equipment such as a dust mask, non-skid safety shoes, hard hat or hearing protection used for appropriate conditions will reduce personal injuries.
- **Prevent unintentional starting. Ensure the switch is in the off-position before connecting to power source and/or battery pack, picking up or carrying the tool.** Carrying power tools with your finger on the switch or energizing power tools that have the switch on invites accidents.

- **Remove any adjusting key or wrench before turning the power tool on.** A wrench or a key left attached to a rotating part of the power tool may result in personal injury.
- **Do not overreach. Keep proper footing and balance at all times.** This enables better control of the power tool in unexpected situations.
- **Dress properly. Do not wear loose clothing or jewelry. Keep your hair and clothing away from moving parts.** Loose clothes, jewelry or long hair can be caught in moving parts.
- **If devices are provided for the connection of dust extraction and collection facilities, ensure these are connected and properly used.** Use of dust collection can reduce dust-related hazards.
- **Do not let familiarity gained from frequent use of tools allow you to become complacent and ignore tool safety principles.** A careless action can cause severe injury within a fraction of a second.

POWER TOOL USE AND CARE

- **Do not force the power tool. Use the correct power tool for your application.** The correct power tool will do the job better and safer at the rate for which it was designed.
 - **Do not use the power tool if the switch does not turn it on and off.** Any power tool that cannot be controlled with the switch is dangerous and must be repaired.
 - **Disconnect the plug from the power source and/ or remove the battery pack, if detachable, from the power tool before making any adjustments, changing accessories, or storing power tools.** Such preventive safety measures reduce the risk of starting the power tool accidentally.
 - **Store idle power tools out of the reach of children and do not allow persons unfamiliar with the power tool or these instructions to operate the power tool.** Power tools are dangerous in the hands of untrained users.
 - **Maintain power tools and accessories. Check for misalignment or binding of moving parts, breakage of parts and any other condition that may affect the power tool's operation. If damaged, have the power tool repaired before use.** Many accidents are caused by poorly maintained power tools.
 - **Keep cutting tools sharp and clean.** Properly maintained cutting tools with sharp cutting edges are less likely to bind and are easier to control.
 - **Use the power tool, accessories and tool bits etc. in accordance with these instructions, taking into account the working conditions and the work to be performed.** Use of the power tool for operations different from those intended could result in a hazardous situation.
 - **Keep handles and grasping surfaces dry, clean and free from oil and grease.** Slippery handles and grasping surfaces do not allow for safe handling and control of the tool in unexpected situations.
- ### BATTERY TOOL USE AND CARE
- **Recharge only with the charger specified by the manufacturer.** A charger that is suitable for one type of battery pack may create a risk of fire when used with another battery pack.
 - **Use power tools only with specifically designated battery packs.** Use of any other battery packs may create a risk of injury and fire.

- When battery pack is not in use, keep it away from other metal objects, like paper clips, coins, keys, nails, screws or other small metal objects, that can make a connection from one terminal to another. Shorting the battery terminals together may cause burns or a fire.

- Under abusive conditions, liquid may be ejected from the battery; avoid contact. If contact accidentally occurs, flush with water. If liquid contacts eyes, additionally seek medical help. Liquid ejected from the battery may cause irritation or burns.

- Do not use a battery pack or tool that is damaged or modified. Damaged or modified batteries may exhibit unpredictable behavior resulting in fire, explosion or risk of injury.

- Do not expose a battery pack or tool to fire or excessive temperature. Exposure to fire or temperature above 130°C (265°F) may cause explosion.

- Follow all charging instructions and do not charge the battery pack or tool outside the temperature range specified in the instructions. Charging improperly or at temperatures outside the specified range may damage the battery and increase the risk of fire.

SERVICE

- Have your power tool serviced by a qualified repair person using only identical replacement parts. This will ensure that the safety of the power tool is maintained.

- Never service damaged battery packs. Service of battery packs should only be performed by the manufacturer or authorised service providers.

SPECIFIC SAFETY RULES FOR ROTARY HAMMERS

- Wear ear protectors. Exposure to noise can cause hearing loss.

- Use auxiliary handle(s), if supplied with the tool. Loss of control can cause personal injury.

- Hold power tools by insulated gripping surfaces, when performing an operation where the cutting tool may contact hidden wiring. Cutting accessory contacting a "live" wire may make exposed metal parts of the power tool "live" and could give the operator an electric shock.

- Keep hands away from all cutting edges and moving parts.

- Maintain labels and nameplates. These carry important information. If unreadable or missing, contact a MILWAUKEE® service facility for a free replacement.

- AWARNING** Some dust created by power sanding, sawing, grinding, drilling, and other construction activities contains chemicals known to cause cancer, birth defects or other reproductive harm. Some examples of these chemicals are:

- lead from lead-based paint
- crystalline silica from bricks and cement and other masonry products, and
- arsenic and chromium from chemically-treated lumber.

Your risk from these exposures varies, depending on how often you do this type of work. To reduce your exposure to these chemicals: work in a well ventilated area, and work with approved safety equipment, such as those dust masks that are specially designed to filter out microscopic particles.

SYMBOLOLOGY



Volts



Direct Current

n_0 xxxmin.⁻¹ No-Load Revolutions per Minute (RPM)



Blows per Minute (BPM)

SPECIFICATIONS

Cat. No.....	M18 CHM
Volts.....	18 DC
Battery Type.....	M18™
Charger Type.....	M18™
No Load RPM.....	0 - 450
BPM.....	0 - 3000
Type.....	SDS-Max
Twist bit.....	40 mm (1-9/16")
Core bit.....	100 mm (4")
Tunnel bit.....	65 mm (2-5/8")

FUNCTIONAL DESCRIPTION

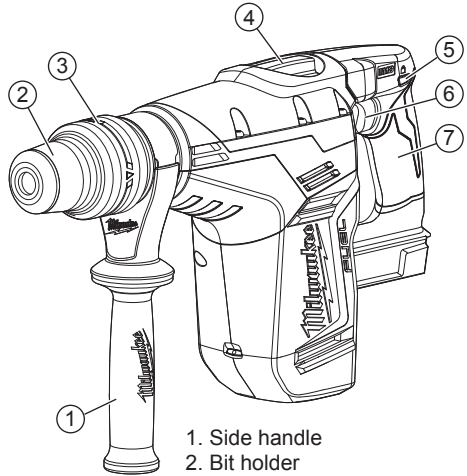

1. Side handle
2. Bit holder
3. Bit release collar
4. Mode selector knob
5. Trigger lock
6. Trigger
7. Trigger handle

ASSEMBLY

⚠WARNING Recharge only with the charger specified for the battery. For specific charging instructions, read the operator's manual supplied with your charger and battery.

Inserting/Removing the Battery

To **remove** the battery, push in the release buttons and pull the battery pack away from the tool.

To **insert** the battery, slide the pack into the body of the tool. Make sure it latches securely into place.

⚠WARNING To reduce the risk of injury, always use a side handle when using this tool. Always brace or hold securely.

Adjusting the Side Handle Position

1. Loosen the side handle by unscrewing the side handle grip until the side handle rotates freely.
2. Rotate the side handle to the desired position.
3. Tighten the side handle grip securely.

Installing Bits and Chisels

Be sure that the shank of the bit is clean. Dirt particles may cause the bit to line up improperly. Do not use bits larger than the maximum recommended capacity of the drill because gear damage or motor overloading may result. For best performance, be sure that the bit is properly sharpened and the shank is lightly greased before use. Use caution when handling hot bits and chisels.

SDS-Max Drive System

1. Remove battery pack
2. Insert the bit or chisel into the nose of the tool.
3. Push bit into tool until it locks.
4. Check to see that the bit is locked by tugging on it.
5. To remove bits and chisels, pull back on the bit release collar and remove bit.

OPERATION

⚠WARNING Always remove battery pack before changing or removing accessories. Only use accessories specifically recommended for this tool. Others may be hazardous.

To reduce the risk of injury, wear safety goggles or glasses with side shields.

To reduce the risk of injury, keep hands away from the bit and moving parts.

Selecting Action

These MILWAUKEE Rotary Hammers have three settings: hammering with rotation, hammering-only, and chisel adjustment.

1. Hammering with rotation. Use this setting for drilling holes with drill bits.
2. Hammering only. For use with "hammering-only" accessories. Use this setting for chiseling or setting self-drilling anchors.
3. Chisel adjustment. Use this setting to adjust the angle of the chisel blade in relation to the tool. With a chisel mounted in the tool:
 - turn the knob to this setting
 - rotate the chisel to the desired angle
 - turn the knob to "hammering-only".

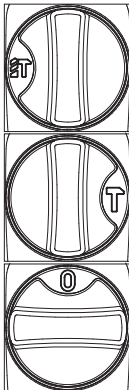

NOTE: To engage the hammering mechanism, maintain pressure on the bit. When the pressure on the bit is released, the hammering will stop.

Starting and Stopping

1. To start the tool, grasp the handle firmly and pull the trigger.
2. To stop the tool, release the trigger. Make sure the tool comes to a complete stop before laying the tool down.

Operating

Position the tool, grasp the handles firmly and pull the trigger. Always hold the tool securely using both handles to maintain control. This tool has been designed to achieve top performance with only moderate pressure. Let the tool do the work.

If the speed begins to drop off when drilling large or deep holes, pull the bit partially out of the hole while the tool is running to help clear dust. Do not use water to settle the dust since it will clog the bit flutes and tend to make the bit bind in the hole. If the bit should bind, a built-in, non-adjustable slip clutch prevents the bit from turning. If this occurs, stop the tool, free the bit and begin again.

Cold Starting

If this tool is stored for a long period of time or at cold temperatures, it may not hammer initially because the lubrication has become stiff. To warm up the tool:

1. Insert and lock a bit or chisel into the tool.
2. Pull the trigger and apply force to the bit or chisel against a concrete or wood surface for a few seconds. Release the trigger
3. Repeat until the tool starts hammering. The colder the tool is, the longer it will take to warm up.

Using Rotary Percussion Core Bits

Core Bits are useful for drilling large or long holes in concrete. MILWAUKEE Heavy-Duty Core Bits have heat-treated steel bodies with durable carbide tips. These core bits are specially designed for fast, accurate drilling with combined hammering and rotary action.

1. Clean and lubricate the threads on the adapter and core bit to make later removal easier. Thread the adapter shank to the rear of the core bit.
2. Push the guide plate onto the pointed end of the centre pin. Insert the centre pin and guide plate assembly into the core bit. Be sure the small end of the centre pin is securely placed into the hole in the centre of the core bit. For LHS systems, screw the threaded end of the centering bit into the core bit.

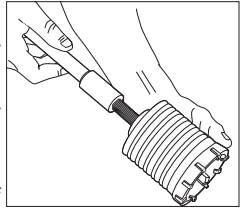

3. Insert the adapter into the nose of the tool as described in "Installing Bits and Chisels". Set the knob to the "hammering with rotation" setting.

4. Press the centering bit firmly against your centre mark, hold the tool firmly and pull the trigger.

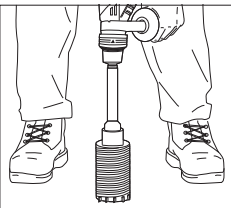

NOTE: If a threaded stud is used, or a centre pin and guide plate are not available, use a template or notched board to start the hole.

5. Start the tool. After drilling to about the depth of the core bit teeth, remove the center pin and guide plate from the core bit (not necessary for LHS system). Resume drilling.

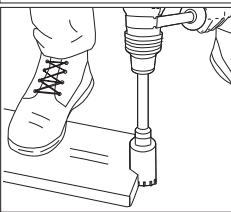

6. To change the core bit, hold the tool upwards, pointing it away from your body, and run it briefly in forward to loosen the core bit from the adapter. **NOTE:** To make deeper holes, remove the core bit, break and remove the core, then resume drilling. When drilling long or deep holes, after each inch of penetration pull the bit partially out of the hole while the tool is running, to help clear dust from the bit flutes. Dust can clog the bit flutes and can make the bit bind in the hole. If this occurs, stop the tool, free the bit and begin again.

Drilling Large Diameter Holes with Core Bits

When drilling holes with large diameter core bits, dust may build up in the cut and can cause the tool to stall, bind, or cut slowly. By creating an opening for the dust to escape, drilling time, bit stress, and tool stress can be reduced.

1. Start the cut as normal.
2. Once the bit is firmly established in the cut (about 6 mm (1/4") deep), remove the bit from the tool.
3. Remove the bit from the tool.
4. Install a standard fluted bit, approximately 22 mm (7/8") in diameter, onto the tool.
5. Drill a perpendicular hole through the kerf of the large hole.
 - Depending on the location of the work, the hole should either break through the other side of the hole/floor or extend 100 mm (4") - 127 mm (5") past the end of the workpiece (such as into the dirt below a concrete slab).
 - If dust builds up in the hole, vacuum it out and continue drilling.
 - If drilling through a wall, the hole for dust should be drilled on the lowest part of the large hole kerf as the dust will fall when drilling and can be evacuated more easily.
6. Reinstall the core bit and continue drilling. Dust and debris will fall through the hole and optimise the cutting ability of the bit.

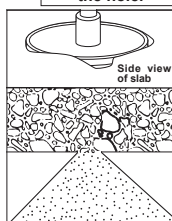
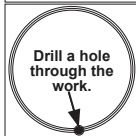
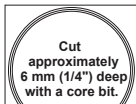

NOTE: If unable to drill a hole in the kerf, pull back on the bit with the hammer running. This will remove some of the dust and debris from the cut. Repeat this for every inch of drilling. If necessary, vacuum dust and debris from the cut and surrounding area.

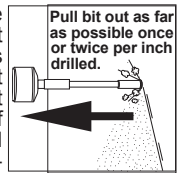

7. For core bits, once the maximum core bit depth is drilled, the core must be broken and removed.
- Install a chisel bit.
 - Place the chisel into the hole kerf.
 - Chisel down into the kerf at several points until the core is loose or broken.
 - Remove the core and vacuum/remove any remaining dust and debris.
 - Install the core bit and continue the cut.



AWARNING To reduce the risk of personal injury and damage to the tool or work:

- Always use the “hammering-only” setting to set the anchor. Never use the “hammering-with-rotation” setting to set the anchor.
- Never switch the tool to “hammering-with-rotation” until after the anchor has been set and the tooth anchor chuck has been removed from the anchor.

Setting Self-Drilling Anchors

MILWAUKEE® Tooth Anchor Chucks require a “B” taper adapter.

1. Place the proper size tooth anchor chuck into the “B” taper adapter. Then insert the “B” taper adapter into the tool and lock it into place as described. See “Installing Bits and Chisels”.
2. Insert the anchor into the tooth anchor chuck. Set the knob for hammering only. Set the anchor on your mark and hammer until the teeth have penetrated the concrete.
 - 3 mm (1/8")
3. Set the knob for hammering with rotation and drill until the chuck is 3 mm (1/8") above the concrete.
 - **NOTE:** It may be necessary to clean dust and cuttings from the anchor several times while drilling the hole.
4. Remove the anchor from the hole while the tool is running. Clean the dust and cuttings from the anchor by pointing it downward and turning the tool on and off several times. Clean the dust out of the hole with a vacuum cleaner or blowout bulb.
5. Place the expansion plug into the anchor and insert the anchor into the hole. Switch the knob back to hammering only, and hammer the anchor firmly into the hole.

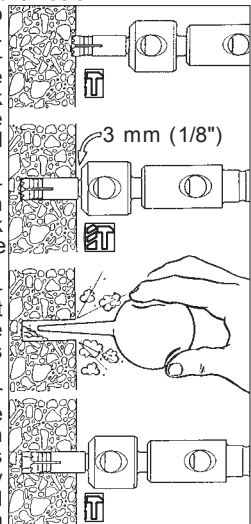



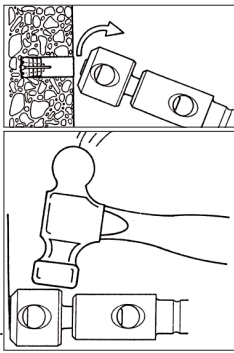



6. Snap the head off of the anchor. To remove the head of anchors up to 16 mm (5/8"), grasp the handles firmly and pull the tool sharply towards you or snap off the anchor head with a hand hammer as shown. The anchor is now ready to receive a bolt.
7. To remove the anchor head wedged in the tooth anchor chuck, use a drift pin.
8. To remove the tooth anchor chuck, remove the "B" taper adapter from the nose of the tool. Insert the drift pin supplied with the adapter into the hole on the side of the "B" taper adapter and strike it sharply to force out the tooth anchor chuck.

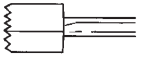

Chiseling and Chipping

MILWAUKEE® Rotary Hammers may be used for chipping and chiseling. When chiseling, hold the tool at an angle to the workpiece. Work from a corner or close to the edge of the workpiece, breaking off one small area at a time rather than attempting too large an area. A variety of accessories are available.

	Bushing Tools Used to surface concrete.
	Mortar Cutting Chisels (Seam Tools) For removing old mortar for tuck pointing or caulking.
	Bull Points For demolition work and starting holes in concrete slabs.
	Flat Chisels For edging, chipping or channeling.
	Scaling Chisels For removing weld spatter or scale and cutting straight lines.
	Slotting Chisel For slotting and cutting between drilled holes in concrete and masonry.

MAINTENANCE

⚠WARNING To reduce the risk of injury, always unplug the charger and remove the battery pack from the charger or tool before performing any maintenance. Never disassemble the tool, battery pack or charger. Contact a MILWAUKEE® service facility for ALL repairs.

Maintaining Tool

Keep your tool, battery pack and charger in good repair by adopting a regular maintenance program. After six months to one year, depending on use, return the tool, battery pack and charger to a MILWAUKEE® service facility for:

- Lubrication
- Mechanical inspection and cleaning (gears, spindles, bearings, housing, etc.)
- Electrical inspection (battery pack, charger, motor)
- Testing to assure proper mechanical and electrical operation

If the tool does not start or operate at full power with a fully charged battery pack, clean the contacts on the battery pack. If the tool still does not work properly, return the tool, charger and battery pack, to a MILWAUKEE® service facility for repairs.

⚠WARNING To reduce the risk of personal injury and damage, never immerse your tool, battery pack or charger in liquid or allow a liquid to flow inside them.

Cleaning

Clean dust and debris from charger and tool vents. Keep tool handles clean, dry and free of oil or grease. Use only mild soap and a damp cloth to clean the tool, battery pack and charger since certain cleaning agents and solvents are harmful to plastics and other insulated parts. Some of these include gasoline, turpentine, lacquer thinner, paint thinner, chlorinated cleaning solvents, ammonia and household detergents containing ammonia. Never use flammable or combustible solvents around tools.

Repairs

For repairs, return the tool, battery pack and charger to the nearest service centre.

ACCESSORIES

⚠WARNING Always remove battery pack before changing or removing accessories. Only use accessories specifically recommended for this tool. Others may be hazardous. For a complete listing of accessories, go online to www.milwaukeetools.com.au/ www.milwaukeetools.co.nz or contact a local distributor.

WARRANTY - AUSTRALIA and NEW ZEALAND

Please refer to Australian and New Zealand warranty supplied with tool. This warranty applies only to product sold in Australia and New Zealand.

AUSTRALIA AND NEW ZEALAND MILWAUKEE® Service

MILWAUKEE® prides itself in producing a premium quality product that is Nothing But Heavy Duty®. Your satisfaction with our products is very important to us! If you encounter any problems with the operation of this tool, please contact your authorised MILWAUKEE® dealer.

For a list of MILWAUKEE® dealers, guarantee or service agents please contact MILWAUKEE® Customer Service or visit our website.

(Australia Toll Free Telephone Number 1300 361 505)

(New Zealand Toll Free Telephone Number 0800 279 624)

or visit www.milwaukeetools.com.au / www.milwaukeetools.co.nz.

Milwaukee Electric Tool Corporation

13135 West Lisbon Road, Brookfield, Wisconsin U.S.A. 53005

Milwaukee Electric Tool Corporation (Australia)

Techtronic Industries (Australia) Pty. Ltd.

Rowville, Victoria, Australia, 3178

Milwaukee Electric Tool Corporation (New Zealand)

Techtronic Industries (New Zealand) Pty. Ltd.

Mangere, Auckland, New Zealand, 2022

Professionally made in China for Milwaukee Electric Tool Corporation